



## A little glowing Halloween ghost



### *Abstract:*

This glowing Halloween ghost is available as a kit from the tuxgraphics online shop. It can glow friendly or it can produce scary flashes. You can choose your own face and make a friendly ghost or a scary monster.

To build this is great fun for all ages.

---

## The idea



We wrap a very bright white LED in bubble padding foil. This foil will diffuse the light. Using transparent adhesive tape the bubble foil is wrapped up and forms a little ball. A little bit smaller than a tennis ball. This little ball is the head of the ghost.

## The kit



The basic "glowing ghost kit" contains the basic parts to build the ghost. The included white LED produces a very bright white light. In addition to this kit we need the atmega8 microcontroller and some batteries or a little DC power supply, 4.5V to 5.5V (Ericsson mobile phone chargers provide 5V DC).



The atmega8 for the "glowing ghost kit" comes pre-loaded with software. You can however also take a plain atmega8 microcontroller and load it yourself with software. The software is available in the download section at the end of this article. For loading the software you will need a programmer like the avrusb500 from tuxgraphics. If you have the programmer hardware and you load the software yourself then you can also modify the software and invent your own blinking patterns.

The software uses PWM (puls width modulation) to control the intensity of the light. The LED can be dimmed to any level and it can flash at any brightness level. It is just a matter of changing the software.

## Building the ghost

First we need to solder the white LED to the long gray wire. Slide the two short insulation tubes onto the wire and then strip the wire at the

ends.

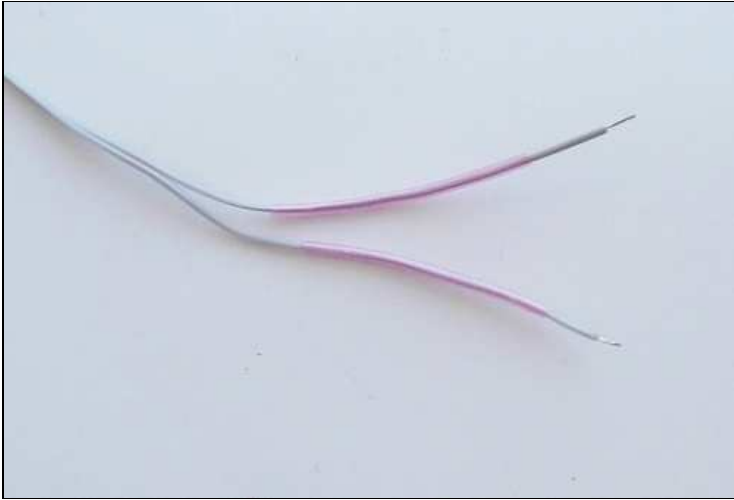

Solder the wire to the LED and then slide the insulation tubes towards the LED to insulate the blank wires.



Wrap the LED in bubble foil. Try to fold the foil such that there is a lot of foil in front of the lens of the LED and not so much foil behind the LED. Remember the light needs to be defused by the foil for this to be effective the light has to go through several layers of bubbles and plastic foil.



The kit includes a black plastic sticker. Cut two eyes and the mouth out of that sticker. You can make a nice and friendly round face or you can make a more scary one with sharp edges (e.g triangular eyes and a zick-zack shaped mouth).



Unfold the white plastic foil on the floor and cut a tidy hole into the center. The gray cables from the LED will go through that hole. Peel the eyes and mouth stickers off and stick them onto the foil slightly below the center.



Now take the LED with the bubble foil ball. Run the gray cable into the center hole of the white foil such that the white foil will hang like a long coat over the bubble foil ball.



Our ghost is ready. You can now test it. Remember never connect an LED directly to the power supply! The kit included a 27 Ohm resistor (color code: red, purple, black). This resistor needs to be used in series with the LED. That is: one wire of the LED goes directly to the power supply the other one connects to one end of the resistor and the other end of the resistor goes to the power supply. You need about 5V.

You can connect 3 AA-Batteries in series (connect plus of one battery to minus of the next) by soldering some short wires to the ends of the batteries. Use a bit of sand paper to scratch and clean the metal surface of the battery before you solder a wire to it. Heat the metal ends of the battery only for a short moment otherwise it is possible that you damage any internal plastic insulation inside the battery. Wrap the 3 batteries together with tape and you have a 4.5V battery block:

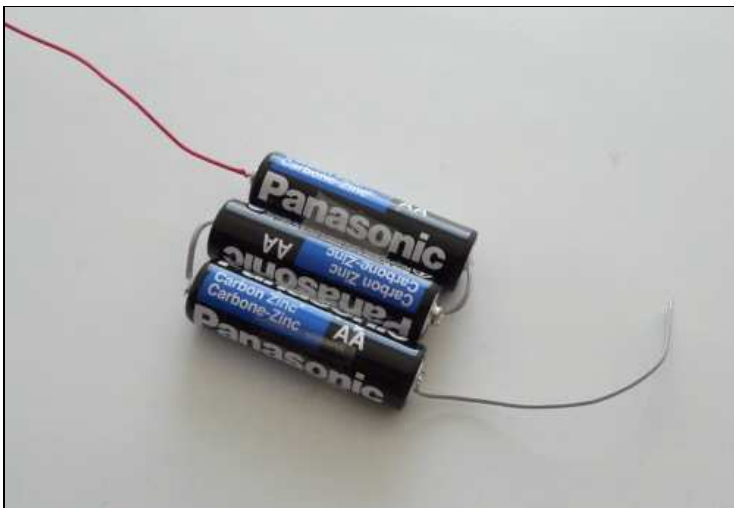

For the LED the polarity is important. If it does not light up then swap the wires. You have found the right polarity when the LED lights up. Note which of the LED wires is plus and which is minus. Mark one of them with a felt tip or a little sticker from the black sticker foil. Later when we connect the ghost to the blink circuit we need to know which one is plus and which one is minus.

## Controlling the LED with a microcontroller

To make the LED flash we need a little bit of electronics. By using a microcontroller we can even generate different glowing and flashing patterns.

The software provided here has two modes: one "glowing" mode where the LED is dimmed up and down continuously and one "flashing puls" mode where the LED flashes with a few short pules and the pauses before it flashes again. The default mode is the "glowing" mode. To get the "flashing pulses" mode you connect pin PD2 to GND (minus, pin 8). You can change the mode at any time.

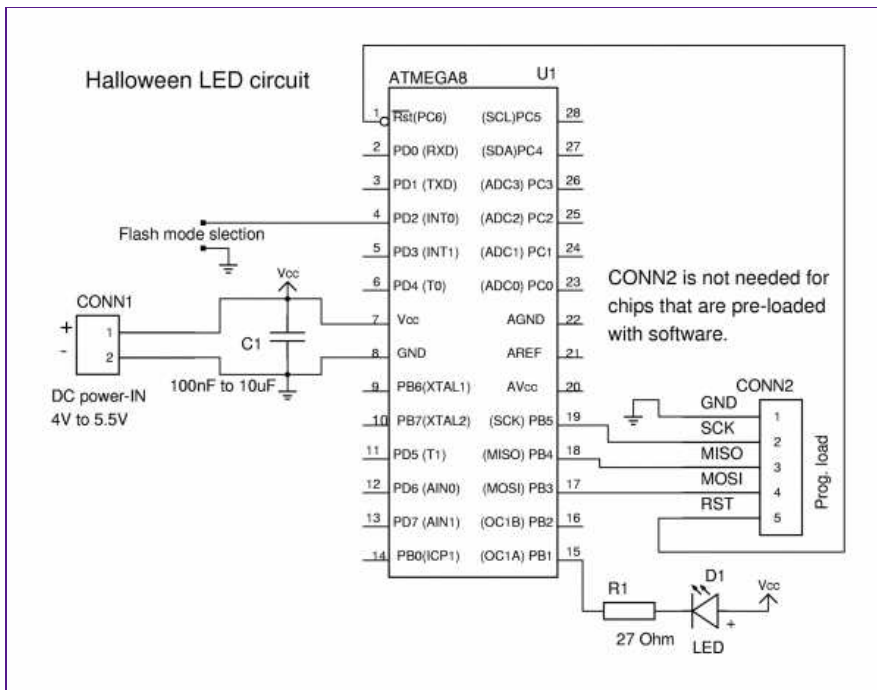

Click on the circuit diagram to open it as PDF file.

The connection to PIN-1 and the whole connector CONN2 (Prog. load) is not needed unless you want to change the software. Normally you just need the power supply connection, the capacitor C1, the resistor and the wires to the LED.

It is important to pay attention to the right polarity of the atmega8 chip. The side where pin one is, is marked on the top of the chip. On the below photos the atmega8 pin-1 would be on the left side of the pictures.

This is what the circuit looks like with the program load connector CONN2.

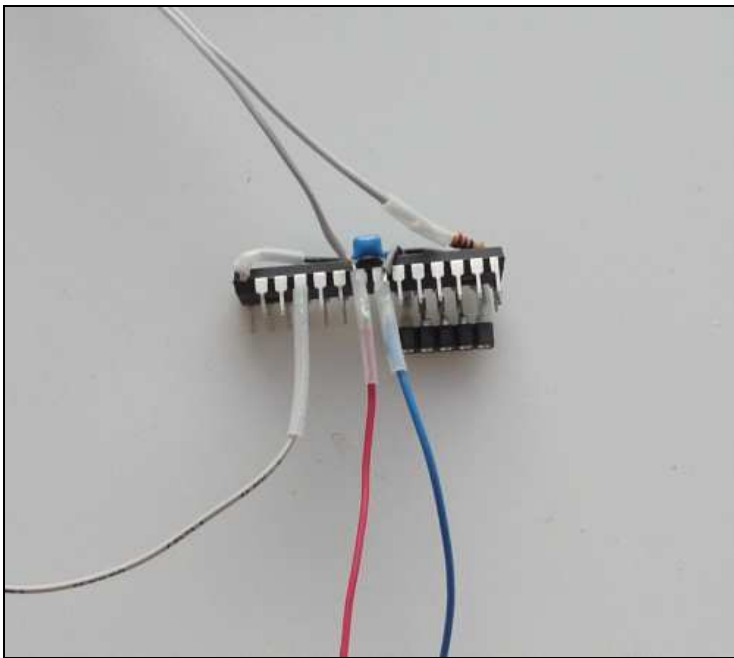

This is what the circuit looks like without the program load connector CONN2.

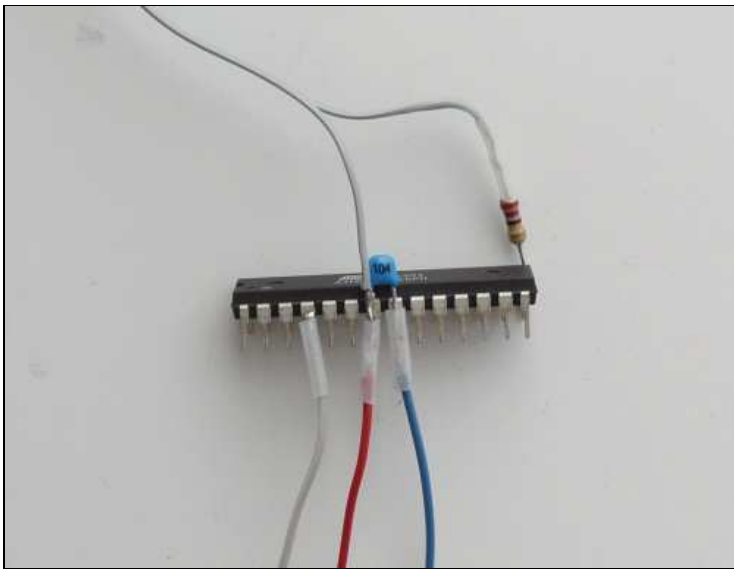

The atmega8 chip comes on some black ESD protection foam. You can cut a stripe off the foam and press it between the pins of the atmega8 chip. It makes it less thorny.

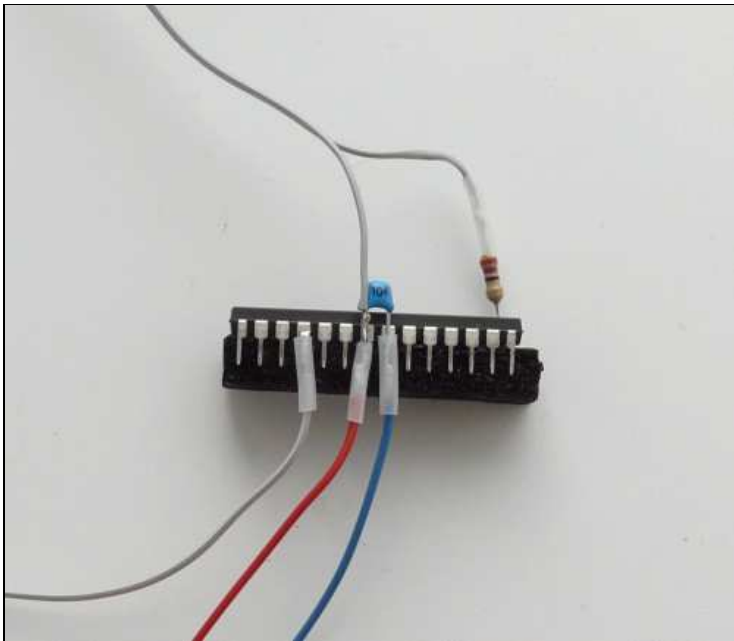

## Waiting for Halloween

Here is the little ghost looking out of the window and waiting for the night to come.



## At night

Here is a video of our ghost at night (in "flashing pulses" mode):

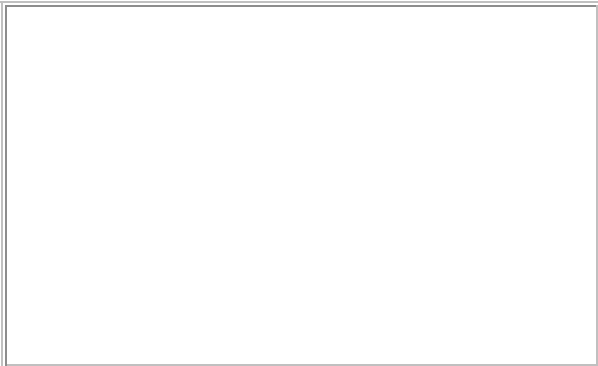

## Great fun for all ages

Building this ghost is great fun for all ages. Younger children need some help with the soldering and the electronics but there are many things they can do already: Wrapping the LED in bubble foil or cutting the face out of the sticker and they will watch fascinated while you build the circuit together with them.

Older children and adults will have fun with the electronics and might try to modify the blinking algorithm. You can create your own flashing



patterns.

I recommend to not build the electronics with very small children (3 years or less) present as they may try to eat those small parts.

## References/Download

- [Download section](#)
- The Halloween ghost kit is available in our online shop: [shop.tuxgraphics.org](http://shop.tuxgraphics.org)

---

© Guido Socher, [tuxgraphics.org](http://tuxgraphics.org)

2009-10-16, generated by tuxgrparser version 2.57